

Semi-Mounted Rollover Plows



[www.KuhnNorthAmerica.com](http://www.KuhnNorthAmerica.com)

**Leader / Manager / Challenger**



**Invest in Quality®**

SEMI-MOUNTED ROLLOVER PLOWS LEADER / MANAGER / CHALLENGER

# A PLOW TO FIT YOUR TILLAGE NEEDS!

Plowing – Sometimes the well-proven ways are best! Long-term, profitable farming requires intimate knowledge of your soil's structure and overall fertility.

With the continued increase of herbicide resistant weeds and crops that produce tremendous volumes of residue, savvy producers have realized the value a plow brings to their tillage practices.

With Kuhn plows, you are investing in a time-tested yet innovative solution for maximizing your crop's yield potential, while at the same time keeping your operating costs in check.

Benefit from a number of improved features including reinforced box sections, rapid adjustment of furrow widths and superior protection systems.

With renowned reliability and long working life, you'll be able to focus on more important things while out in the field.

## SEMI-MOUNTED ROLLOVER PLOWS in brief:

Models	Main Frame Size	Number of Bodies (Per Side)
Multi-Leader	7"	6 – 8
Multi-Leader OL	7"	6 – 8
Vari-Leader	7"	6 – 8
Vari-Leader OL	7"	6 – 8
Manager	7"	5 – 8
Vari-Manager	7"	5 – 8
Challenger OL	8 ½"	7 – 12





# PLOW BODIES DESIGNED TO SAVE ON COSTS



## MOLDBOARDS WITH UNEQUAL LAYER TRIPLEX® STEEL

Moldboards are made of unequal layer, heat-treated Triplex steel that have an increased working life up to 40% and a hard wearing surface over 1/8" thick.

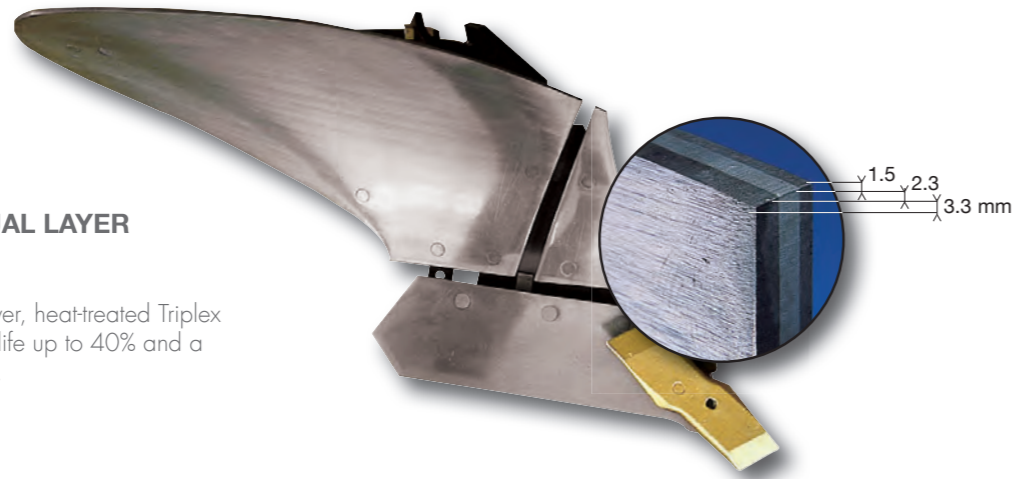

## DESIGNED TO REDUCE WEARING COST

Forged with a force of 6,000 tons ensuring:

- Excellent wear resistance
- Self-sharpening profile due to the grain in the steel resulting from the forging process

# CHOOSE THE MOLDBOARD THAT FITS YOUR SOIL CONDITIONS

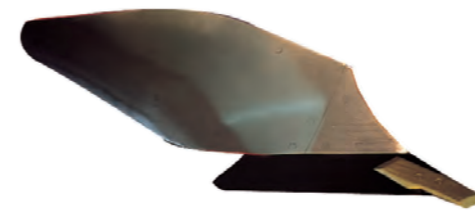

## H4 MOLDBOARD

The H4, helicoidal, Scandinavian-type moldboard provides well-formed plowing to a normal depth range of 7-12" (H6 will plow to 14"). The share is fitted with a reversible/replaceable point that greatly increases the life of the share.

Recommended for fall plowing, the H4 body is especially suited for heavy and damp clays. Furrow passes are well defined and trash burial is excellent.



## N MOLDBOARD

The helicoidal-cylindrical, semi-digger N moldboard plows to a depth of 14". Designed with a highly versatile body, it is cylindrical at the front and helicoidal at the rear. A low draft ensures a partly broken furrow with excellent trash burial.

Recommended for spring plowing, this moldboard is versatile and works well in sandy or clay soils.



## VP SLATTED MOLDBOARD

The VP slatted moldboard is composed of independent and interchangeable slats creates a reduction of traction force in order to lower the moldboard surface area.

This moldboard is designed for use in extremely sticky muck and clay soils, but is not for use in soils with rocks or stones. The multiple slats allow individual replacement from wear.

## MOLDBOARD POINTS

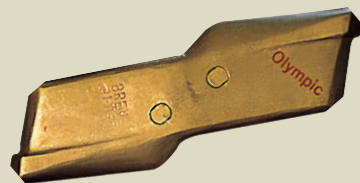

### OLYMPIC (Standard)

Reversible for maximum efficiency. More pronounced form at wearing zones on the point for longer life and better protection of the landside. Point is self sharpening for good ground penetration at all times.



### MARATHON

Reversible for maximum efficiency and features a step, resulting in better landside protection.



### SUPER MARATHON

Fitted with a tungsten carbide tip. High wear resistance with four to five times the life of a traditional share point. A sharp working edge is maintained for excellent ground penetration. Excellent for highly abrasive soils without rocks or stones.



# CHOOSE YOUR PLOW LEG PROTECTION

With Kuhn plows you can customize your plow leg protection to best suit your working conditions. Traction bolt security is an economical choice and is best suited for sandy or loam soils free of large rocks. Non-stop hydraulic reset is the trouble-free choice for rocky or hard soils, and provides ultimate protection with continuous plowing.



## TRACTION BOLT\* – AVOIDS THE PROBLEMS OF SHEAR BOLTS

A clean break of the traction bolt, following a force of 5,280 – 8,820 pounds at the plow point, avoids the risk of nuisance shearing.

- The bolt (A) runs in the direction of the line of force and is pulled apart – unlike shear bolts which are cut
- The bolt support never deforms or becomes rounded
- Once the bolt breaks, it simply falls away for quick and easy replacement
- After years of use the plow bodies remain perfectly in line

\*Not available on Vari-Leader or Manager series plows

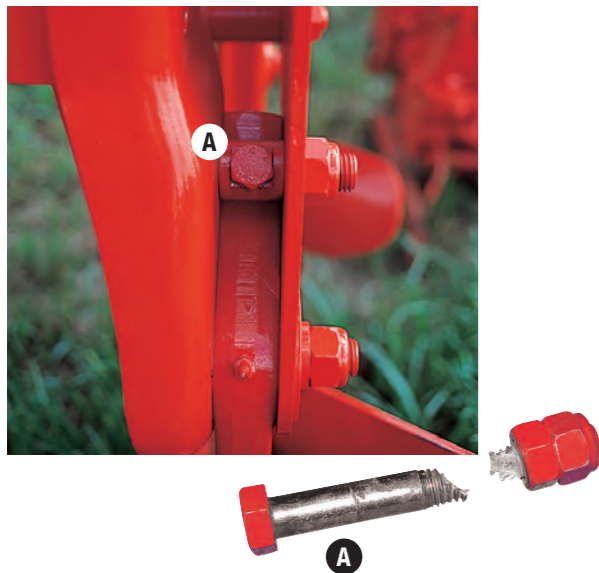

## NON-STOP HYDRAULIC (NSH) RESET

When a field obstacle is met, a rapid breakaway of the plow leg occurs. Once the obstacle is passed there is an increase in pressure, bringing the body quickly and firmly back into working position. The system also acts as a shock absorber in rocky ground, increasing plow life.

### BENEFITS:

- Each bottom is 55 pounds lighter than a mechanical auto reset system
- Share points lift up 24" or move 8" to either side
- More reliability and less wear with hydraulic technology
- Quick share point adjustments from 1,320 – 2,860 pounds

### NSH OPTIONS

VariBar system: allows for instant control of the trip release pressure from the tractor cab (with or without MaxiBar).

MaxiBar system: allows the top tripping pressure to be increased from 2,860 – 5,500 pounds, while maintaining the flexibility of the system. Recommended for very hard soils such as dried clay.

## HEAVY-DUTY PLOW LEG ARTICULATION AND TIE ROD

All force is transmitted in a straight line through a one-piece, forged and heat-treated tie.



# CUSTOMIZE YOUR TRASH BURIAL



## TRASHBOARD

Enhances trash burial in difficult conditions where the quantity of trash may otherwise block up the skimmers.



## HELICOIDAL ZH SKIMMER

Helicoidal skimmer provides deep trash burial and is well adapted to grasslands and fields with cover crop.



## ZRL HIGH CAPACITY SKIMMER

High-capacity skimmer incorporates trash throughout the soil profile including excellent straw and corn trash burial.



## DISC COULTERS

Discs have a diameter of 20", plain or notched, with the added choice on the traction bolt models of a 23" disc. The disc serves to cut the furrow wall in front of the plow body giving a cleaner finish and improving trash incorporation.

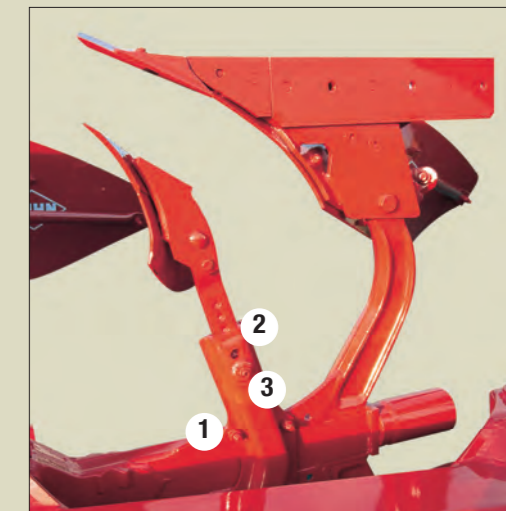

## INDEPENDENT, ADJUSTABLE SKIMMERS

Each skimmer is independent of another and firmly held in a sheath-like support. The skimmers are shear bolt protected and are adjustable in three directions:

- 1 Forward and backward – with a choice of three positions, the sheath bolts to the leg support via countersunk holes to avoid any risk of free play.
- 2 Up and down – rapid and precise height adjustment (8" of adjustment) with countersunk holes in the skimmer leg for easy locking of the leg for the desired height.
- 3 Side to side – for correct adjustment in relation to the disc coulters (where fitted).



## PRESS ARMS WITH HYDRAULIC RELEASE

The press arms allow for the use of a furrow press with easy hookup and hydraulic push off. On the pickup hook part of the arm, where there is the most risk of damage, all grease zerks and hydraulic hoses are protected inside the structure of the head. The arm folds up conveniently for transport.



# UNRIVALED STRENGTH FOR INTENSIVE PLOWING

## THE MULTI-LEADER ADVANTAGE:

Multi-Leader plows feature a headstock adaptable for most mid-size tractors. The plow turns over without jolts and is perfect for plowing on the edges of a field. Working width per body can be set via adjusting bolts.

### MULTI-LEADER

Working Width per Body	Total Working Width		
	Number of Bodies		
	6	7	8
14"	7'	8'	9'
16"	8'	9'	10'
18"	9'	10'	12'
20"	10'	11'	13'

## THE VARI-LEADER ADVANTAGE:

On Vari-Leader plows, cutting width can be adjusted on-the-go from the cab. This is beneficial for plowing in smaller and non-square fields, and when plowing different soil types.

### VARI-LEADER

Working Width per Body	Total Working Width		
	Number of Bodies		
	6	7	8
14"	7'	8'	9'
16"	8'	9'	10'
18"	9'	10'	12'
20"	10'	11'	13'
22"	11'	12'	14'



SEMI-MOUNTED ROLLOVER PLOWS LEADER

## OPTIMIZED PLOWING

Working right up to the edge of the field is necessary to get the most out of your cropland while limiting weed development. To meet this requirement, Kuhn has integrated the wheel extremely close to the frame due to its Z shape. In this way, the overhang is greatly reduced.

An extra-large wheel is necessary to reduce the traction requirement, provide good bearing capacity and for operation in difficult end-of-season conditions. Two types of extra-large wheels are available on these plows for differing conditions.



### FORWARD COMPATIBLE

A 6-body plow can increase to 7 or 8 bodies with extensions that are bolted to the front. This allows you to upgrade your plow, should you get a larger tractor, and helps preserve your resale value.



Hydraulic sequencing comes standard meaning fewer valves to operate during headland turns.

# SIMPLE SETTINGS FOR OPTIMUM WORK QUALITY

Quality plowing makes seedbed preparation easier and reduces power consumption. This is possible through precise, easily accessible settings. Leveling, working depth and offset adjustments are tool free.



Spacers on the left cylinder provide plenty of depth. The number of spacers allows for a point of reference and is axial.



Leveling is independent, left or right via stop for extra precision.



Adjusting the plow's offsets is done by either a mechanical tie rod or hydraulic cylinder (optional). This adjustment can go from 3 1/4' to 5 3/4'. A gauge visible from the tractor allows for precision setting of the machine.

# POWERFUL STRUCTURE PROVIDES RELIABILITY

The design and construction of the Leader range plows are suited for the most intense working conditions.



A wide range of hitch categories are available (Cat. 3, 4N, 4, Quick hitch 3 and 4N) to adapt to medium and high power tractors (135 to 360 hp).



A stub axle mounted on tapered roller bearings makes this turning system incredibly reliable.



With two telescopic, single-acting cylinders, headland turns are jolt free. This also reduces stress on the tractor's lift arms allowing for optimum comfort during progressive turns.



For added reliability, the structure is made using a large, machine-welded frame measuring approximately 7" x 7".



A large (20" x 40" or 20" x 47") tire supported on both sides ensures stability in headland turns and provides a longer hub life. The 20" x 47" lug-type tire shown above is recommended for NSH plows with 7 or 8 bodies.



For more stability in transport, as well as frame protection during road travel, the lifting cylinder is equipped with hydropneumatic suspension.



# MAXIMUM VERSATILITY: ON-LAND AND IN-FURROW PLOWING



## ON-LAND OFFSET IS AVAILABLE TO ENHANCE PRODUCTIVITY

The soil sometimes requires wide or dual tires that cannot be used for in-furrow plowing. If the tractor is setup for other applications that require duals or wide tires, if equipped with the on-land kit it is no longer necessary to dismount the wheels in order to use it for plowing.

In addition, on-land plowing has other advantages too:

- No smoothing effect at the bottom of the furrow
- Reduced wear on the sidewalls of the tires in rocky conditions

## VERSATILE ON-LAND KIT

This kit can be used on tractors with up to 10'6" overall width.



## WORKING QUALITY

Two large-diameter wheels (27") ensure bodies work at a constant depth. This means each wheel can be adjusted separately to obtain perfect results.



## USER COMFORT

Ease of use is always important when handling large machinery. With this system, there are less hydraulic valves to operate on headlands. Hydraulic sequencing also allows for automatic folding of the offset when the plow is being lifted.



# A SEMI-MOUNTED PLOW FOR MAXIMUM VERSATILITY

With a wide choice of bodies and trash burial options, Manager semi-mounted plows are suited for medium range horsepower tractors and working conditions. For operators plowing hilly or undulating terrain, the Manager plows provide exceptional ground following due to their articulated design. With Manager plows, you can use the same sized horsepower tractor with more bodies than if you were using a mounted plow. They are available as a bolted fixed cutting width Multi-Manager or a hydraulically adjustable cutting width Vari-Manager that can be adjusted from the cab.

## SHARP TURNING ANGLE OF 110° FOR EXCELLENT TRANSITIONS

The undercarriage wheels can be directed left or right according to the direction required by slightly turning the plow to one side or the other with the turnover mechanism. The center-mounted wheels are closer to the tractor compared to a rear-mounted, single-wheel system, which allows a more in-line finish to plowing, along with a better turning angle and subsequently shorter headlands. The specially designed headstock articulation joint gives an impressive 110° turning angle.



## HEADSTOCK WITH HEAVY-DUTY ARTICULATION

The swift hitch cross shaft is positioned low on the machine for the best possible weight distribution and maximum traction in difficult conditions.

# THE ALL AROUNDER



## HYDRAULIC SEQUENCING **PATENTED**

In the tractor cab, the same lever controls both the lifting out of work and turnover of the plow in one combined automatic operation; greatly simplifying headland maneuvers and reducing driver fatigue.

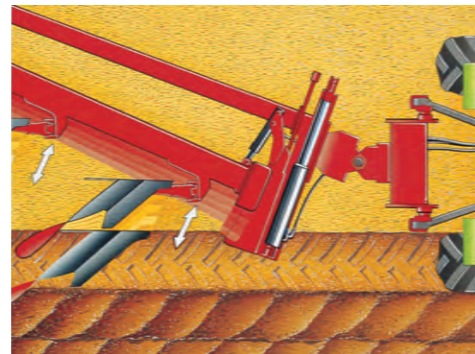

## LARGE HYDRAULIC OFFSETTING ADJUSTMENT

Large adjustments can be made to the plow offsetting (its angle in relation to the tractor) from the tractor seat by activating one of the hydraulic valve levers. This allows for easy adaptation to all possible tractor inter-wheel distances.



## THE TWO-WHEEL UNDERCARRIAGE

The undercarriage results in a substantial reduction in the strain put on the tractor arms during turnover. This engineering concept lowers the center of gravity. Turnover is carried out by two-direct acting, horizontal rams with no complex mechanical linkages. This very simple turnover system has a small amount of moving parts, reducing both the risks of wear and possible maintenance requirements. The system comes complete with a hydraulic leveling lock.



## BEAM ARTICULATION **PATENTED**

The beam articulation allows the plow to follow undulating terrain for a constant plowing depth along the length of the plow. When coming out of work, while the front bodies are lifted out of the ground, the rear bodies remain at a constant working depth giving reduced headlands and a neater finish.

The articulation locks automatically when coming out of work and remains locked during all movement. The articulation is unlocked as soon as the plow is put back into work.

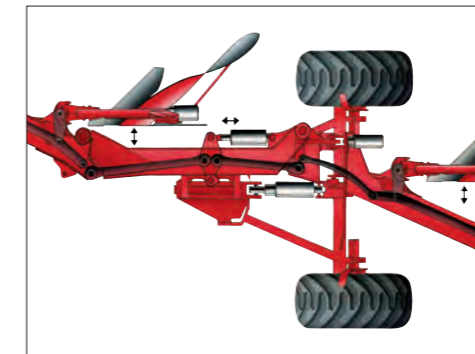

## ALL MOVING PARTS FULLY INTEGRATED INTO THE PLOW BEAM

- The linkage mechanism responsible for the variable width changes is housed inside the plow beam (Vari-Manager)
- All links and moving joints are fully protected from abrasive agents (dust, corrosion, any possible impact damage)
- The plow beam ensures a long, trouble-free, working life



## ADVANTAGES OF THE VARIABLE WIDTH SYSTEM

- Adapts quickly to available traction
- Adapts to different soil types, ground undulations and field sizes while maintaining a high work rate
- Alternates the plow profile between summer and winter
- Copes with large amounts of trash
- Neatly finishes up to the field border
- Avoids obstacles and forms a tidier furrow



# KUHN'S SOLUTION FOR HIGH HORSEPOWER TRACTORS

The Challenger is without a doubt, the plow for high horsepower tractors and extremely difficult working conditions. The number of bodies ensures the highest working rate is achieved. The Challenger's 8 1/2" beam section provides durability during work and combined with its safety system (traction bolt or non-stop security), ensures a long life. On-land plowing is standard to adapt to the large tractor's required offsetting adjustment.



## LARGE OFFSETTING ADJUSTMENT

Large adjustments can be made to the plow offsetting (its angle in relation to the tractor) from the tractor seat by simply activating a hydraulic lever. This allows for easy adaptation to all possible tractor inter-wheel distances and also permits a complete cancellation of the effect of the first body for particular circumstances, i.e., finishing a field, going around obstacles, etc.

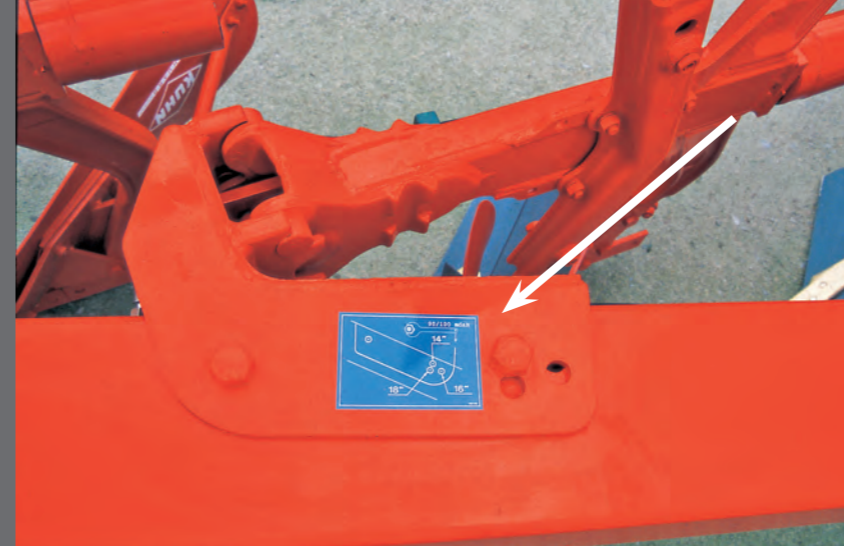

## MULTIPLE WORKING WIDTHS – 14", 16" AND 18"

Whether a traction bolt model or non-stop hydraulic (NSH), changes in working width to settings of either 14", 16" or 18" are quick and easy to carry out. The width-setting bolt is removed and the plow legs pivot to the desired width. The rear beam angle is changed in the same manner as the articulation joint it moves positions corresponding to the required setting width.



## ON-LAND PLOWING

Benefits:

- Greater distribution of weight load, lowering compaction to a minimum
- Reduced tire wear on rocky ground
- Extra-wide tires or dual wheels can be used
- Time savings – not necessary to disassemble dual wheels for plowing

The Challenger can be easily transformed back to an "in-furrow" plow if wet conditions reduce traction on land. A front-mounted depth wheel is essential when working in the on-land position.



# OPTIONAL EQUIPMENT



**DEPTH AND TRANSPORT WHEELS**

The 20" steel or 24" rubber wheel follows any change of plowing widths and features simple depth adjustment by screw adjuster, with the possibility of setting left and right sides differently. It can be placed in many positions on the frame to ensure optimum positioning for all conditions.



**REAR DEPTH CONTROL WHEEL**

Fitted with a 24" (Manager series) or 27" (Challenger series) tire, the rear beam mounted depth wheel pivots freely from side-to-side to follow all changes in working width. The wheel is simply designed and easy to adjust. Depth adjustments are easy to execute by turning the handle screw with the possibility to set the depth independently left from right.



**DEPTH WHEEL WITH SHOCK ABSORBER**

This option is available for the Challenger plows in 27" diameter with rubber tire. The shock absorber not only removes the shock of the wheel falling during turnover, but also ensures the wheel is in the correct rearward, inclined position as the plow is lowered back into work.

## READY, SET... PLOW! (KEY STEPS TO OPTIMIZE PLOWING)

1. Measure tire pressure and distance between rear tractor tires.
2. Adjust each according to outlined recommendations.
3. Adjust 3-point lower links to be in the rearmost position (and not allowed to float vertically).
4. Measure and adjust 3-point lower links so that both are the same length.
5. Set 3-point top link according to conditions.
6. Preset skimmers to the desired working depth.
7. Set depth control wheel for plowing depth desired.
8. Set side-to-side leveling turn knob so that sidewall forms a 90° angle. Set opposite side turn knob for the same thread length.
9. Adjust top link turnbuckle length so plow body is horizontal when in work.
10. Set first body width to make share slightly overlap the uncut ground.



	MULTI-LEADER 6	MULTI-LEADER 7 (6+1)	MULTI-LEADER 8 (6+1+1)	VARI-LEADER 6	VARI-LEADER 7 (6+1)	VARI-LEADER 8 (6+1+1)
<b>DIMENSIONS</b>						
Number of Bottoms Per Side	6	7	8	6	7	8
Extendable by One Bottom	Yes		No		Yes	No
H4 Long Helicoidal Moldboards	Standard					
Working Width	14", 16", 18" or 20" (Delivered at 16")			14" - 22" Hydraulically Adjustable		
Hydraulic Rollover with Two Cylinders	Standard					
On-Land Hitch Kit	Available as Separate Model Only					
Hitch Type	Cat. 3 (Cat. 3 Quick Hitch Compatible / 4N Quick Hitch through Options)					
Maximum Tractor PTO	270 hp (201 kW)	315 hp (235 kW)	360 hp (268 kW)	270 hp (201 kW)	330 hp (246 kW)	385 hp (287 kW)
Clearance						
- Point-to-Point	40" (102 cm)					
- Underbeam	31 1/2" (80 cm)					
Adjustable Depth Wheel with Tire	Standard					
Offset Adjustment	Standard Hydraulic Offset and Angling Adjustment					
Hydraulic Beam Folding	Standard with Memory Cylinder					
Machine Net Weight						
- T	7,220 lbs. (3,275 kg)	7,936 lbs. (3,600 kg)	8,653 lbs. (3,925 kg)	-	-	-
- NSH	7,760 lbs. (3,520 kg)	8,565 lbs. (3,885 kg)	9,370 lbs. (4,250 kg)	8,487 lbs. (3,850 kg)	9,402 lbs. (4,265 kg)	10,273 lbs. (4,660 kg)

	MANAGER 5	MANAGER 6	MANAGER 7	MANAGER 8
Number of Bottoms Per Side	5 (3+2)	6 (4+2)	7 (4+3)	8 (5+3)
Extendable by One Bottom	Yes, at Rear		Yes, at Front	No
H4 Long Helicoidal Moldboard	Standard			
Articulated Beam and Headstock	Standard			
Working Width	14", 16" or 18" (Delivered at 16")			
Hitch Type	Cat. 2 (Cat. 3 available through Options)			
Maximum Tractor PTO	150 hp (112 kW)	180 hp (134 kW)	210 hp (157 kW)	240 hp (179 kW)
Clearance				
- Point-to-Point	40" (102 cm)			
- Underbeam	31 1/2" (80 cm)			
Adjustable Depth Wheel with Tire	Standard			
Offset Adjustment	Hydraulic			
Tires	Standard Two Tractor Tread Tire			
Machine Net Weight				
- NSH	6,404 lbs. (2,905 kg)	7,043 lbs. (3,195 kg)	7,683 lbs. (3,485 kg)	8,318 lbs. (3,773 kg)

	VARI-MANAGER 5	VARI-MANAGER 6	VARI-MANAGER 7	VARI-MANAGER 8
Number of Bottoms Per Side (F & R)	5 (3+2)	6 (4+2)	7 (4+3)	8 (5+3)
Extendable by One Bottom	Yes, at Rear		Yes, at Front	No
Articulated Beam and Headstock	Standard			
H4 Long Helicoidal Moldboards	Standard			
Working Width	12" to 20"			
Hitch Type	Cat. 2 (Cat. 3 available through Options)			
Maximum Tractor PTO	150 hp (112 kW)	180 hp (134 kW)	210 hp (157 kW)	240 hp (179 kW)
Clearance				
- Point-to-Point	40" (102 cm)			
- Underbeam	31 1/2" (80 cm)			
Adjustable Depth Wheel with Tire	Standard			
Offset Adjustment	Hydraulic			
Sequence Valve - Combines Lift & Roll Functions	Optional			
Machine Net Weight				
- NSH	7,198 lbs. (3,265 kg)	7,910 lbs. (3,588 kg)	8,617 lbs. (3,909 kg)	9,332 lbs. (4,505 kg)

	CHALLENGER 7	CHALLENGER 8	CHALLENGER 9	CHALLENGER 10	CHALLENGER 11	CHALLENGER 12
Number of Bottoms Per Side (F & R)	7 (4+3)	8 (5+3)	9 (5+4)	10 (6+4)	11 (8+3)	12 (8+4)
Extendable by One Bottom	Yes, at Front	Yes, at Rear	Yes, at Front	No	Yes, at Rear	No
H4 Long Helicoidal Moldboards	Standard					
Working Width	14" or 16" or 18" (Delivered at 16")					
Hydraulic Rollover with Two Cylinders	Standard					
On-Land Hitch Kit	Standard					
Hitch Type	Cat. 3 (Cat. 4 available through Options)					
Maximum Tractor PTO	250 hp (186 kW)	285 hp (213 kW)	320 hp (239 kW)	335 hp (250 kW)	390 hp (291 kW)	425 hp (317 kW)
Clearance						
- Point-to-Point	40" (102 cm)					
- Underbeam	31 1/2" (80 cm)					
Adjustable Depth Wheel with Tire	Standard					
Offset Adjustment	Hydraulic					
Sequence Valve - Combines Lift & Roll Functions	Standard					
Two Wheel Undercarriage with Suspension in Transport	Standard					
Machine Net Weight						
- T	10,214 lbs. (4,633 kg)	10,888 lbs. (4,939 kg)	11,739 lbs. (5,325 kg)	12,418 lbs. (5,633 kg)	13,146 lbs. (5,963 kg)	13,884 lbs. (6,298 kg)
- NSH	10,618 lbs. (4,816 kg)	11,372 lbs. (5,158 kg)	12,262 lbs. (5,562 kg)	13,017 lbs. (5,904 kg)	13,890 lbs. (6,300 kg)	14,701 lbs. (6,668 kg)

# COMPLEMENTARY PRODUCTS

## MORE PRODUCTS TO MEET YOUR NEEDS

With over 700 models of equipment, we have the most complete implement line in the industry. Whether you have a small or large operation, we have a broad range of models and options to help fit your diverse needs.



1. Power Tillers
2. Power Harrows
3. Combo Discs / Shanks
4. Fertilizer Spreaders
5. Mounted Mechanical Grain Drills
6. Trailed Grain Drills

For more information about your nearest Kuhn dealer and other Kuhn products, visit our website at [www.KuhnNorthAmerica.com](http://www.KuhnNorthAmerica.com)



Visit our YouTube channel to watch our latest product videos.

### KUHN NORTH AMERICA, INC.

Corporate Headquarters  
 1501 West Seventh Avenue - Brodhead, WI 53520  
 Phone: (608) 897-2131 Fax: (608) 897-2561

Information given in this document is only for informational purposes and is non-contractual. Our machines are in compliance with North American safety standards. In our literature, and for improved illustration of certain details, some safety devices may not be in operating position. When operating these machines, these devices must be operated in accordance with the requirements indicated in the operator's manuals and assembly manuals. We reserve the right to change any designs, specifications or materials listed without further notice. Machines and equipment in this document can be covered by at least one patent and/or registered design. Trademarks cited in this document may be registered in one or several countries.

 <a href="http://www.KuhnNorthAmerica.com">www.KuhnNorthAmerica.com</a>	<p>Your Kuhn dealer</p>
---	-------------------------

Find us on

